







Risk &  
Safety Services





## Safe Work Procedure

### Welding Safety

RSS 18.35.4

<b>Program/Services</b> Trades, and Visual Arts	<b>Safe Work Procedures</b>		<b>Department:</b> Risk and Safety Services		
<b>Personal Protective Equipment or Devices Used</b> <ul style="list-style-type: none"> <li>• Safety Glasses.</li> <li>• Welding Helmets with protective lenses meeting shade selection. requirements for the task.</li> <li>• Work Boots.</li> <li>• Respirator with HEPA filters must be worn when working hazardous fumes. Workers <b>MUST</b> be fit tested prior to performing any hazardous work.</li> <li>• Welding Gloves.</li> <li>• Hard Hats</li> <li>• Protective Clothing (welding jacket, welding gloves, respirator).</li> </ul>	<b>Training Requirements</b> <ul style="list-style-type: none"> <li>• In class safety training</li> <li>• Hands-on safety training in the shop</li> </ul>	<b>Applicable Documents</b>	<b>Effective Date:</b>		
			April 23, 2019		
			<b>Date Reviewed</b>		
			Revision Date	Revision #	Authorized
			Aug 26, 2024	3	Safety Advisor

<p><b>ELECTRICAL HAZARD</b></p>  <p>Do not attempt to service electrical wires.</p>	<p><b>PINCH POINTS</b></p>  <p>Use LOCK-OUT procedures when performing maintenance or conducting any work within 12" of an exposed pinch point.</p> <p><b>NEVER</b> put your hands or feet near an exposed pinch point or gears!</p>	<p><b>HIGH SOUND LEVELS</b></p>  <p><b>HEARING PROTECTION</b> is required when working in designated.</p> <p>Required when Sound levels exceed 85 dB areas.</p>	<p><b>FOOT INJURY</b></p>  <p>Approved protective footwear is required when there is the risk of foot injury due to slipping, uneven terrain, and abrasion, crushing potential, temperature extremes, corrosive substances, puncture hazards, electrical shock and any other recognizable hazard.</p>	<p><b>CAUTION</b></p>  <p>Loose or dangling items (jewelery) must <b>NOT</b> be worn while operating any equipment or machines.</p>
<p><b>UV Light</b></p>	<p><b>EXPLOSIVE</b></p>	<p><b>EXPOSURE</b></p>	<p><b>FIRE</b></p>	<p><b>FOOT INJURY</b></p>

 <p>Ensure you are taking safety means to protect yourself from UV rays while welding.</p>	 <p>Make sure volatile chemicals are stored and handled correctly. Proper grounding must be used for all containers.</p>	 <p>Understand the chemical(s) you are working in the vicinity of. Consult the SDS and wear the appropriate PPE.</p>	 <p>Ensure that your work area is clear of combustible materials that could start a fire as a result of welding sparks.</p>	 <p>The appropriate ASTM or CSA approved footwear must be worn when job hazard analysis shows it is required.</p>
---	---	---	--	--

## PROCEDURES

### Welding

Welding is a joining process in which metals or sometimes plastics are heated, melted and mixed to produce a joint with properties similar to those of the materials being joined.

There are three main components needed to create a weld. These are:

- A heat source such as an electric arc, a flame, pressure, or friction. The most common heat source is an electric arc. An arc is a physical gap between the end of the electrode and the base metal. The physical gap causes heat due to the resistance of the current flow and arc rays. The arc melts to create the joint.
- Shielding, which is the use of gas or another substance to protect the weld from the air as the weld is being formed. Oxygen from the air makes welds brittle and porous.
- Filler material, which is the material used to join the two pieces together.

Other processes that join metals together include:

- Brazing is the joining of metals with a filler metal having a melting point above 450C, but below the melting points of the base metals.
- Soldering is the joining of metals using a filler metal with a melting point below 450C. The joined metals can be different metals. The filler metals commonly used are lead-tin alloys.

Metals can also be cut or separated by a flame or an electric arc or removed by gouging with an electric arc.

## Types of welding processes

There are over 70 different processes, the most common of which are:

- Shield Metal Arc Welding (SMAW) also known as Manual Metal Arc Welding (MMAW).
- Gas Tungsten Arc Welding (GTAW) or Tungsten Inert Gas (TIG) Welding.
- Flux Cored Arc Welding (FCAW).
- Gas Metal Arc Welding (GMAW), also known as Metal Inert Gas (MIG) Welding or hand wire welding.
- Plasma Arc Welding (PAW), Plasma Arc Cutting (PAC) and gouging.
- Submerged Arc Welding (SAW).
- Resistance Arc Welding (RW) or spot welding.
- Air Carbon Arc Cutting and Gouging.
- Oxyfuel welding, cutting, and heating (oxygen-acetylene [oxyacetylene] or oxygen-propane [oxy-propane] mixtures are the most common fuel mixtures used.

## General hazards associated with welding.

HAZARD	WELDING PROCESS			
	PAW/PAC Air Carbon Arc Processes	SMAW GTAW GMAW FCAW	SAW	Oxyfuel
Ergonomic	✓	✓	✓	✓
Electric Shock	✓	✓	✓	X
Bright light	✓	✓	(✓)	✓
Ultraviolet radiation	✓	✓	(✓)	X
Toxic fumes and gases	✓	✓	(✓)	✓
Heat, fire and burns	✓	✓	✓	✓
Noise	✓	X	X	X

X indicates no hazards, ✓ indicates hazard present, (✓) indicates hazard present if SAW flux is absent.

## **Welding –Electrical Safety**

Follow electrical welding safety procedures to prevent electrical hazards.

Electricity used in welding is available as:

- Single phase 120 Volts (V) or 240 Volts (V)
- Triple phase 575 Volts (V) in Canada and 480 Volts (V) in the USA

Never connect an American triple phase power supply directly to a Canadian triple phase voltage input. You will destroy the transformer and possibly injure yourself or others.

## **Power Supplies**

All power supplies must meet the guidelines set by CSA standard C22.1 Canadian Electrical Code, 19<sup>th</sup> edition, 2009 (in Canada) or ANSI/NFPA 70 (2011) National Electrical Safety Code (in the USA), or by the local electrical utility or another appropriate body.

## Common Electrical Hazards

### Electric Shock

The human body conducts electricity. Even low currents may cause severe health effects. Spasms, burns, muscle paralysis, or death can be a result depending on the amount of the current flowing through the body, the route it takes, and the duration of exposure.

Effects of Electrical Shock	
Effect	DC Current (mA)
Death	120+
Ventricular Fibrillation	50-120
Paralysis of Diaphragm	20-50
Makes hands "clamp-on"	16-20
Involuntary Reflexes	4-9
Perception	1

### Completion of the circuit through the body

- If a person touches a live conductor, current may flow through the body to the ground and cause a shock.
- Increased electrical contact with the ground increases the risk of shock.
- Avoid standing in water, on wet surfaces, or working with wet hands or wearing sweaty garments.
- Small shocks could surprise you and cause you to slip and fall.



### What to do in case of electric shock



- Call for medical help!
- **DO NOT** touch the victim with your "bare hands" until he or she is away from the live electrical source.
- Turn off power at the fuse box or circuit breaker panel. If you can do it safely, turn off the appliance or electrical equipment and unplug it. Just turning off the equipment is not sufficient.

- If the electricity cannot be turned off and the victim is still in contact with the electrical source, decide if you must move the victim or push the wire away from the victim (call for emergency help if the wire is a high voltage power line)
- Insulate yourself if you must move a victim away from a live contact – wear dry gloves or cover your hands with a cloth and stand on dry insulating material like cardboard, wood or clothes. Ensure you have a good footing and will not slip or fall when trying to move the victim.
- Use a dry piece of wood or broom handle or other dry, insulating object or material to move the wire or power source away from the victim or push the victim of the live electrical source.
- Once clear of any live electrical source or lines, call first aid to attend to the victim.

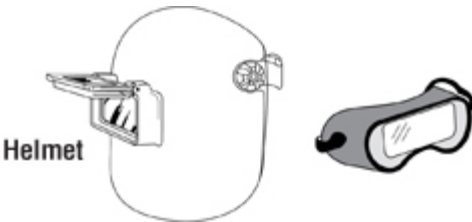
### Personal Protective Equipment

The chart below summarizes the types of personal protective equipment that can be used When welding.

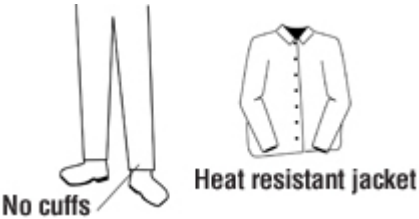
<b>Welding - Personal Protective Equipment</b>			
<b>Body Part</b>	<b>Equipment</b>	<b>Illustration</b>	<b>Reason</b>
Eyes and face	Welding helmet, hand shield, or goggles	 <p>The illustration shows a welding helmet on the left with the word 'Helmet' written below it. To the right of the helmet is a pair of safety goggles.</p>	Protects from: <ul style="list-style-type: none"> <li>• Radiation</li> <li>• hot slag, sparks</li> <li>• intense light</li> <li>• irritation and chemical burn</li> <li>• Wear fire resistant head coverings under the helmet where appropriate.</li> </ul>
Lungs (breathing)	Respirators	 <p>The illustration shows a person's head and shoulders wearing a respirator mask that covers the nose and mouth.</p>	Protects against: <ul style="list-style-type: none"> <li>• fumes and oxides</li> </ul>

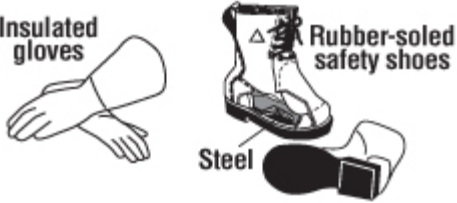
Exposed skin (other than feet, hands, and head)	Fire/Flame resistant clothing and aprons		Protects against: <ul style="list-style-type: none"> <li>• heat, fires</li> <li>• burns</li> </ul> Notes: pants should not have cuffs, shirts should have flaps over pockets or be taped closed
Ears - hearing	Earmuffs, ear plugs		Protects against: <ul style="list-style-type: none"> <li>• noise</li> </ul> Use fire-resistant ear plugs where sparks or splatter may enter the ear.
Feet and hands	Boots, gloves		Protects against: <ul style="list-style-type: none"> <li>• electric shock</li> <li>• heat</li> <li>• burns</li> <li>• fires</li> </ul>

## Eye Protection

### Importance of eye protection

An eye injury can occur from the intense light and radiation that a welding arc can produce. An eye injury can also occur from hot slag that can fly off from the weld during cooling, chipping or grinding.

- Protect your eyes from welding light by wearing a welder's helmet fitted with a filter shade that is suitable for the type of welding you are doing.
- **ALWAYS** wear safety glasses with side shields or goggles and face shield when chipping or grinding a workpiece. Always wear safety glasses under a welding helmet for additional protection from flying metal slag.

### Types of eye and face protection appropriate for welding tasks

The various types of eye protection are broken down into classes in the Canadian Standards Association (CSA) standard Z94.3.1 "Selection, use,

and care of protective eyewear." Each class has a specific use that it has been designed for. Common protectors for welding operations are listed below:

- Class 2C - direct non-ventilated goggles with radiation protection
- Class 3 - welding helmets
- Class 4 - hand shields
- Class 5C - non-rigid helmets with radiation protection
- Class 6B - face shields with radiation protection
- Class 7B - respirator facepiece with radiation protection

The following operations require full face protection from either a welding helmet or a hand shield:

- Arc welding
- Plasma arc cutting, gouging or welding
- Air carbon arc cutting

For gas cutting, welding, or brazing, the intensity of the light is much less than from arc welding, cutting or gouging processes. Lighter shade filter lenses can be used with goggles in place of a helmet.

### **Components of welding hand shields and helmets**

Hand shields or helmets provide eye protection by using an assembly of components:

- Helmet shell - must be opaque to light and resistant to impact, heat, and electricity.
- Outer cover plate made of polycarbonate plastic which protects from UV radiation, impact, and scratches.
- Filter lens made of glass containing a filler which reduces the amount of light passing through to the eyes. Filters are available in different shade numbers ranging from 2 to 14. The higher the number, the darker the filter and the less light passes through the lens.
- Clear retainer lens made of plastic prevents any broken pieces of the filter lens from reaching the eye.
- Gasket made of heat insulating material between the cover lens and the filter lens protects the lens from sudden heat changes which could cause it to break. In some models, the heat insulation is provided by the frame mount instead of a separate gasket.

### **Welding helmet filter shade selection**

For Arc welding, the correct filter shade is selected according to the welding process, wire diameter, and operating current. The table below gives the correct shade numbers for different situations.

- ALWAYS use suggested shade numbers instead of minimum shades



### Shade Numbers for Selected Arc Processes (from CSA W117.2)

Process	Electrode Diameter (mm)	Current (Amperes)	Minimum Shade	Suggested Shade
SMAW	< 2.5	< 60	7	-
	2.5 - 4	60 - 160	8	10
	4 - 6.4	160 - 250	10	12
	> 6.4	250 - 550	11	14
GMAW FCAW MCAW		< 60	7	-
		60 - 160	10	11
		160 - 250	10	12
		250 - 500	10	14
Air Carbon Arc Cutting light heavy		< 500	10	12
		500 - 1000	11	14

*\*In the United States use ANSI/AWS Standard F2.2 for selecting filter lens shades.*

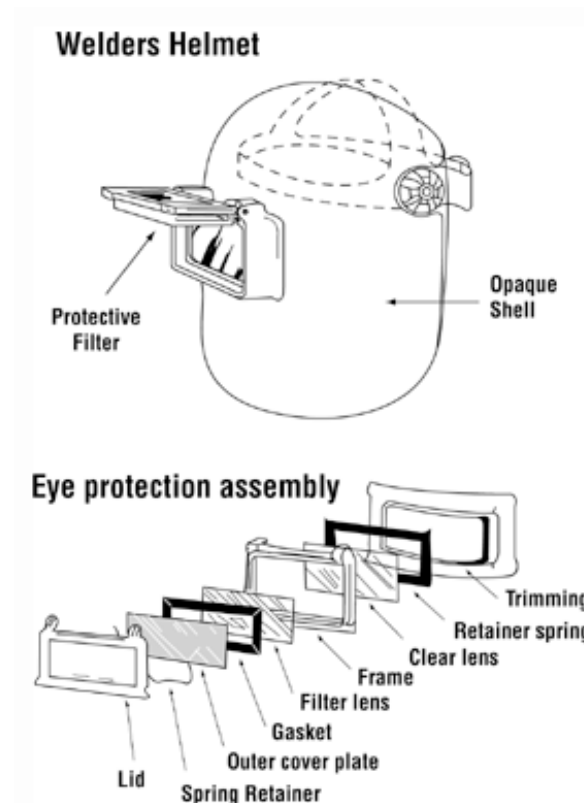

- Provide additional task lighting that suits welders' needs.
- Use the same shade as the welder's if you are directly observing the welding arc.
- Do not use gas welding goggles for arc welding.
- Do not substitute modified glasses, sunglasses, smoke plastic or other materials for proper welding lenses.

The correct shade numbers for oxy-fuel cutting are shown in the table below.

**Shade Numbers for Cutting (from CSA W117.2)**

Process	Plate Thickness (in mm)	Minimum Shade #	Suggested Shade #
Light	< 25	3	4
Medium	25 - 150	4	5
Heavy	> 150	5	6

*\* In the US use ANSI/AWS Standard F2.2 for selecting filter lens shade.*

### **Contact lenses use when welding**

The CSA Standard W117.2 states that contact lenses should not be worn by welders and welding personnel. Contact lenses do not provide protection from ultraviolet radiation and flying objects. All workers in proximity to welding procedures must wear appropriate eye protection according to the circumstances.

### **Measures to be taken for skin protection from welding radiation**

- Wear tightly woven work-weight fabrics to keep UV radiation from reaching your skin.
- Button up your shirt to protect the skin on the throat and neck.
- Wear long sleeves and pant legs.
- Cover your head with a fabric cap to protect the scalp from UV radiation.
- Protect the back of your head by using a hood.
- Protect your face from UV radiation by wearing a tight-fitting, opaque welder's helmet.
- Make sure that all fabric garments are resistant to spark, heat and flame. Keep the fabrics clean and free of combustible materials that could be ignited by a spark.

### **Respirator use during welding tasks**

Respiratory protection is needed when ventilation is not sufficient to remove welding fumes or when there is a risk of oxygen deficiency. Select and use respirators in compliance with your workplace regulation. Seek expert advice and initiate a proper respiratory protection program.

The process of selecting appropriate respiratory protection is outlined in the Canadian Standards Association (CSA) standard Z94.4 and American National Standards Institute (ANSI) Z88.2 standard "Respiratory Protection."

### **Safety tips for using protective clothing**

- Wear clothing made from heavyweight, tightly woven, 100% wool or cotton to protect from UV radiation, hot metal, sparks, and open flames. Flame retardant treatments become less effective with repeated laundering.
- Keep clothing clean and free of oils, greases, and combustible contaminants.
- Wear long-sleeved shirts with buttoned cuffs and a collar to protect the neck. Dark colors prevent light reflection.

- Tape shirt pockets closed to avoid collecting sparks or hot metal or keep them covered with flaps.
- Pant legs must not have cuffs and must cover the tops of the boots. Cuffs can collect sparks.
- Repair all frayed edges, tears or holes in clothing.
- Wear high top boots fully laced to prevent sparks from entering into the boots.
- Use fire-resistant boot protectors or spats strapped around the pant legs and boot tops, to prevent sparks from bouncing in the top of the boots.
- Remove all ignition sources such as matches and butane lighters from pockets. Hot welding sparks may light the matches or ignite leaking lighter fuel.
- Wear gauntlet-type cuff leather gloves or protective sleeves of similar material, to protect wrists and forearms. Leather is a good electrical insulator if kept dry.
- Direct any spark spray away from your clothing.
- Wear leather aprons to protect your chest and lap from sparks when standing or sitting.
- Wear layers of clothing. To prevent sweating, avoid overdressing in cold weather. Sweaty clothes cause rapid heat loss. Leather welding jackets are not very breathable and can make you sweat if you are overdressed.
- Wear a fire-resistant skull cap or balaclava hood under your helmet to protect your head from burns and UV radiation.
- Wear a welder's face shield to protect your face from UV radiation and flying particles.

### **DO NOT**

- Do not wear rings or other jewelry.
- Do not wear clothing made from synthetic or synthetic blends. The synthetic fabric can burn vigorously, melt and produce bad skin burns.

### **Welding radiations and the effects on eyes and skin**

#### **Types of radiation associated with welding**

- Welding arcs give off radiation over a broad range of wavelengths - from 200 nm (nanometers) to 1,400 nm (or 0.2 to 1.4  $\mu\text{m}$ , micrometers). This includes ultraviolet (UV) radiation (200 to 400 nm), visible light (400 to 700 nm), and infrared (IR) radiation (700 to 1,400 nm).

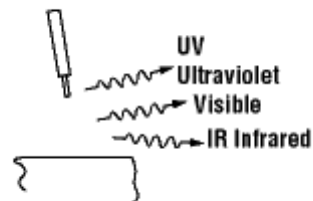

- UV-radiation is divided into three ranges - UV-A (315 to 400 nm), UV-B (280 to 315 nm) and UV-C (100 to 280 nm). UV-C and almost all UV-B are absorbed in the cornea of the eye. UV-A passes through the cornea and is absorbed in the lens of the eye.
- Some UV radiation, visible light, and IR radiation can reach the retina.

## **Symptoms of Arc Eye**

Certain types of UV radiation can produce an injury to the surface and mucous membrane (conjunctiva) of the eye called "arc eye," "welders' eye" or "arc flash." These names are common names for "conjunctivitis" - an inflammation of the mucous membrane of the front of the eye.

### **The symptoms include:**

- Pain - ranging from a mild feeling of pressure in the eyes to intense pain in severe
- Tearing and reddening of the eye and membranes around the eye
- The sensation of "sand in the eye" or abnormal sensitivity to light
- Inability to look at light sources (photophobia)

The amount of time required to cause these effects depends on several factors such as the intensity of the radiation, the distance from the welding arc, the angle at which the radiation enters the eye, and type of eye protection that the welder or bystander is using. However, exposure to just a few seconds of intense UV light can cause arc eye. These symptoms may not be felt until several hours after exposure.

### **Possible effects to the eyes**

- Long-term exposure to UV light can produce cataracts in some persons.
- Visible light from welding processes is very bright and can overwhelm the ability of the iris of the eye to close sufficiently and rapidly enough to limit the brightness of the light reaching the retina. The result is that the light is temporarily blinding and fatiguing to the eye.
- A serious concern is the "blue light hazard" which is the temporary or permanent scarring of the retina due to its sensitivity to blue light, around 440 nm wavelength. Blindness may result.
- Exposure to infrared light can heat the lens of the eye and produce cataracts over a long term.

## **Skin hazards associated with welding and radiation**

Welding arcs and flames emit intense visible, ultraviolet, and infrared radiation.

- UV radiation in a welding arc will burn unprotected skin just like UV radiation in sunlight. This is true for direct exposure to UV radiation as well as radiation that is reflected from metal surfaces, walls, and ceilings. Surface finishes and certain paint colors can reduce the amount of UV radiation that is reflected.
- Long-term exposure to UV radiation can cause skin cancer.
- Infrared radiation and visible light normally have very little effect on the skin.

## Radiation Protection

- Arc welding must not be carried out unless workers who may be exposed to radiation from the arc flash are protected by adequate screens, curtains or partitions or wear suitable eye protection.
- A screen, curtain or partition near an arc welding operation must be made of or be treated with a flame-resistant material or coating and must have a non-reflective surface finish.

**Note:** 12 m (40 ft.) is the recommended minimum distance from which an electric welding arc should be seen by the unprotected eye.

## Welding Fumes

### Composition of welding fumes

- Welding fumes are a complex mixture of metallic oxides, silicates, and fluorides. Fumes are formed when a metal is heated above its boiling point and its vapors condense into very fine, particles (solid particulates).
- Yes, welding fumes contain oxides of the metals in the material being welded.
- Vapors or fumes can come from coatings and residues on metal being welded. Some ingredients in coatings can have toxic effects.

### These ingredients include

- metalworking fluids, oils, and rust inhibitors
- zinc on galvanized steel (vaporizes to produce zinc oxide fume)
- cadmium plating
- vapors from paints and solvents
- lead oxide primer paints
- some plastic coatings

Metal Coatings - A Source of Hazardous Fumes

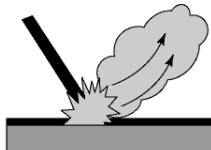

## **Welding Gases**

Welding gases are gases used or produced during welding and cutting processes like shielding gases or gases produced by the decomposition of fluxes or from the interaction of ultraviolet light or high temperatures with gases or vapors in the air.

### **Examples of Welding Gases**

Gases used in welding and cutting processes include:

- Shielding gases such as carbon dioxide, argon, helium, etc.
- Fuel gases such as acetylene, propane, butane, etc.
- Oxygen, used with fuel gases and also in small amounts in some shielding gas mixtures

Gases produced from welding and cutting processes include:

- Carbon dioxide from the decomposition of fluxes
- Carbon monoxide from the breakdown of carbon dioxide shielding gas in arc welding
- Ozone from the interaction of electric arc with atmospheric oxygen
- Nitrogen oxides from the heating of atmospheric oxygen and nitrogen
- Hydrogen chloride and phosgene produced by the reaction between ultraviolet light and the vapors from chlorinated hydrocarbon degreasing solvents (e.g., trichloroethylene, TCE)

Gases are also produced from the thermal breakdown of coatings:

- Polyurethane coatings can produce hydrogen cyanide, formaldehyde, carbon dioxide, carbon monoxide, oxides of nitrogen, and isocyanate vapors.
- Epoxy coatings can produce carbon dioxide and carbon monoxide.
- Vinyl paints can produce hydrogen chloride.
- Phosphate rust-inhibiting paints can release phosphine during welding processes.
- Minimizing exposure to degreasing solvent vapors.

**Table 1**  
**Source and Health Effect of Welding Fumes**

<b>Fumes Type</b>	<b>Source</b>	<b>Health Effect</b>
Aluminum	Aluminum component of some alloys, e.g., Inconel, copper, zinc, steel, magnesium, brass and filler materials.	Respiratory irritant.
Beryllium	Hardening agent found in copper, magnesium, aluminum alloys and electrical contacts.	"Metal Fume Fever." A carcinogen. Other chronic effects include damage to the respiratory tract.
Cadmium Oxides	Stainless steel containing cadmium or plated materials, zinc alloy.	Irritation of the respiratory system, sore and dry throat, chest pain and breathing difficulty. Chronic effects include kidney damage and emphysema. Suspected carcinogen.
Chromium	Most stainless-steel and high-alloy materials, welding rods. Also used as a plating material.	Increased risk of lung cancer. Some individuals may develop skin irritation. Some forms are carcinogens (hexavalent chromium).
Copper	Alloys such as Monel, brass, bronze. Also some welding rods.	Acute effects include irritation of the eyes, nose, and throat, nausea and "Metal Fume Fever."
Fluorides	Common electrode coating and flux material for both low- and high-alloy sheets of steel.	Acute effect is irritation of the eyes, nose, and throat. Long-term exposures may result in bone and joint problems. Chronic effects also include excess fluid in the lungs.
Iron Oxides	The major contaminant in all iron or steel welding processes.	Siderosis – a benign form of lung disease caused by particles deposited in the lungs. Acute symptoms include irritation of the nose and lungs. Tends to clear up when exposure stops.

Lead	Solder, brass and bronze alloys, primer/coating on steels.	Chronic effects on the nervous system, kidneys, digestive system, and mental capacity. Can cause lead poisoning.
Manganese	Most welding processes, especially high-tensile steels.	"Metal Fume Fever." Chronic effects may include central nervous system problems.
Molybdenum	Steel alloys, iron, stainless steel, nickel alloys.	Acute effects are eye, nose and throat irritation, and shortness of breath.
Nickel	Stainless steel, Inconel, Monel, Hastelloy and other high-alloy materials, welding rods and plated steel.	Acute effect is irritation of the eyes, nose, and throat. Increased cancer risk has been noted in occupations other than welding. Also associated with dermatitis and lung problems.
Vanadium	Some steel alloys, iron, stainless steel, nickel alloys.	Acute effect is irritation of the eyes, skin and respiratory tract. Chronic effects include bronchitis, retinitis, fluid in the lungs and pneumonia.
Zinc	Galvanized and painted metal.	Metal Fume Fever.

**Table 2**  
**Source and Health Effect of Welding Gases**

<b>Gas Type</b>	<b>Source</b>	<b>Health Effect</b>
Carbon Monoxide	Formed in the arc.	Absorbed readily into the bloodstream, causing headaches, dizziness or muscular weakness. High concentrations may result in unconsciousness and death
Hydrogen Fluoride	Decomposition of rod coatings.	Irritating to the eyes and respiratory tract. Overexposure can cause lung, kidney, bone and liver damage. Chronic exposure can result in chronic irritation of the nose, throat, and bronchi.
Nitrogen Oxides	Formed in the arc.	Eye, nose and throat irritation in low concentrations. Abnormal fluid in the lung and other serious effects at higher concentrations. Chronic effects include lung problems such as emphysema.



Oxygen Deficiency	Welding in confined spaces, and air displacement by shielding gas.	Dizziness, mental confusion, asphyxiation, and death.
Ozone	Formed in the welding arc, especially during plasma-arc, MIG and TIG processes.	Acute effects include fluid in the lungs and hemorrhaging. Very low concentrations (e.g., one part per million) cause headaches and dryness of the eyes. Chronic effects include significant changes in lung function.

**Table 3**  
**Source and Health Effect of Organic Vapours as a result of Welding**

Gas Type	Source	Health Effect
Aldehydes (such as formaldehyde)	Metal coating with binders and pigments. Degreasing solvents	Irritant to eyes and respiratory tract.
Di-isocyanates	Metal with polyurethane paint.	Eye, nose and throat irritation. High possibility of sensitization, producing asthmatic or other allergic symptoms, even at very low exposures.
Phosgene	Metal with residual degreasing solvents. (Phosgene is formed by reaction of the solvent and welding radiation.)	Severe irritant to eyes, nose and respiratory system. Symptoms may be delayed.
Phosphine	Metal coated with rust inhibitors. (Phosphine is formed by reaction of the rust inhibitor with welding radiation.)	Irritant to eyes and respiratory system can damage kidneys and other organs.

### Hazards from Welding Gases

Hazards from welding gases include:

- Asphyxiation (lack of oxygen)
- Fire or explosion
- Toxicity

## **Prevention of exposure to Welding Gases**

It is important to follow the manufacturer's instructions, SDS, and safety protocols to minimize the hazards of welding gases.

- Use substitute materials such as water-based cleaners or high flash point solvents.
- Cover the degreaser baths or containers
- Do not weld on surfaces that are still wet with a degreasing solvent.
- Do not weld near degreasing baths
- Do not use chlorinated hydrocarbon degreasers.
- Have adequate ventilation in a workplace to prevent the displacement or enrichment of oxygen and to prevent the accumulation of flammable atmospheres.

## **Welding Ventilation**

### **Guidelines for Welding Ventilation**

Ventilation is used for three general purposes:

- Remove air contaminants from a worker's breathing zone,
- Prevent the accumulation of flammable or combustible gases or vapors; and,
- Prevent oxygen rich or oxygen-deficient atmospheres

For processes such as welding, brazing, soldering, and torch cutting, the primary purpose of ventilation is to remove air contaminants from the worker's breathing zone.

Different ventilation strategies may be needed in each case to remove air contaminants from the welder's breathing zone. General guidelines have been published in CSA W117.2 Safety in Welding, Cutting, and Allied Processes, and ANSI Z49.1 Standard Safety in Welding and Cutting.

### **Types of ventilation systems to remove air contaminants**

Ventilation strategies fall into three general categories:

- Natural Dilution Ventilation
- Mechanical Dilution Ventilation
- Local Exhaust Ventilation

Dilution ventilation adds new fresh air to an area and can be accomplished by non-mechanical means such as opening windows and doors, or mechanical means such as wall and roof exhaust fans.

## Natural Dilution Ventilation

Weld out of the plume. Use a tight-fitting welding helmet to shield you from the plume. By opening doors, windows and other openings in a building's structure, fresh air can be added to an area to decrease the concentration of an airborne contaminant and eventually remove it. This type of ventilation is generally considered the least effective because there is no direct control over how the airborne contaminants will move through the work area.



Natural dilution ventilation should not be used to ventilate confined spaces, an area that has a structural impediment to natural airflow, or when the airborne contaminant contains a carcinogenic substance or other substance of high toxicity. See CSA W117.2 for specific guidance.

## Mechanical Dilution Ventilation

Mechanical dilution ventilation uses wall fans, roof exhaust fans, or other mechanical means to prevent airborne contaminants from entering a worker's breathing zone.

## Local Exhaust Ventilation

Local exhaust ventilation (LEV) is always the preferred method of removing welding fumes and gases. It exhausts or removes the toxic gases, fumes, dust, and vapors before they can mix with the room air.

A well-designed welding helmet can help reduce a welder's exposure to welding fumes by diverting the plume away from the welder's breathing zone.

## Examples of Local Exhaust Ventilation Systems

### Downdraft Bench

A downdraft bench has an open grid work surface. Air is drawn downward through the grid, drawing contaminants into exhaust ducting. Airspeed must be great enough to keep contaminants from rising into your breathing zone. If workpieces are too large they may block the ventilation airflow or cause pockets of high-velocity air (which could affect shielding gases).

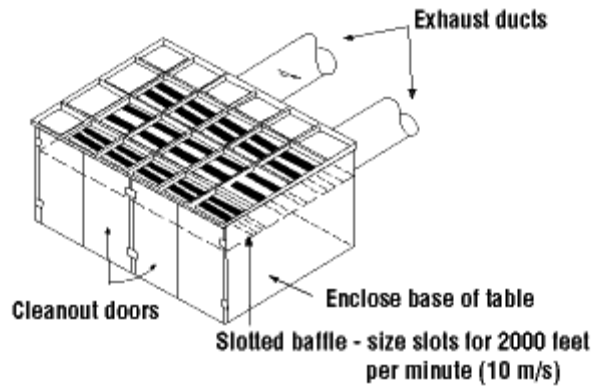

### Moveable Hood

Flexible ducting allows the capture hood to be moved where required. Provide an air velocity of at least 100 ft. /min (0.5 m/s) across the welding arc. Place the hood as close as practical to the work. The optimal location for the hood is about 1 duct diameter from the arc.

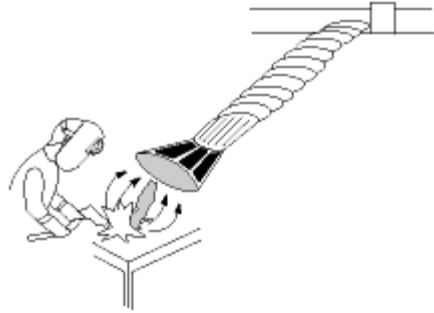

### **Fume Extraction Welding Guns**

The contaminants are removed very close to the source of generation and are drawn through a hose into the exhaust system. They can be very effective on flat and vertical surfaces or in corners and around flanges.

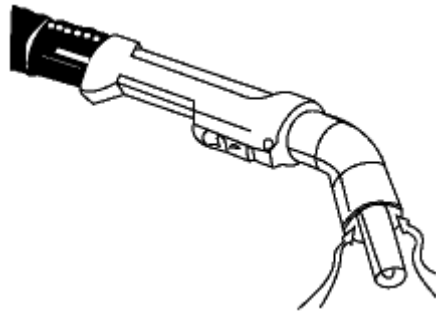

### **Storage and Handling of Compressed Gas Cylinders**

#### **Storing Compressed Gas Cylinders**

- Check your fire code for guidelines regarding the storage of flammable gas cylinders.
- Store cylinders in a clearly identified, dry, well-ventilated storage area away from doorways, aisles, elevators, and stairs.
- Post "no smoking" signs in the area.
- Store cylinders in the upright position and secure with an insulated chain or non-conductive belt.
- Secure the protective caps.
- Ensure that the area is well ventilated. With outside storage, place on a fireproof surface and enclose in a tamper-proof enclosure.
- Protect cylinders from contact with the ground, ice, snow, water, salt, corrosion, and high temperatures.

- Store oxygen and fuel gases separately. Indoors, separate oxygen from fuel gas cylinders by at least 6 meters (20 feet), or by a wall at least 1.5 m (5 ft.) high with a minimum half-hour fire resistance. (From CSA W117.2-06 "Safety in welding, cutting, and allied processes". Local jurisdiction requirements may vary.)

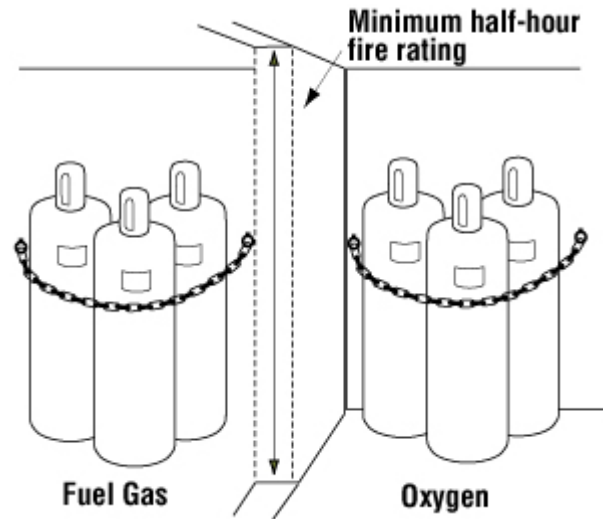

### **Avoid doing the following**

- Do not use a cylinder as an electrical ground connection.
- Do not fasten cylinders to a work table or to structures where they could become part of an electrical circuit.
- Do not strike an arc on a cylinder.
- Do not use a flame or boiling water to thaw a frozen valve. Valves or cylinders may contain fusible plugs which can melt at temperatures below the boiling point of water.

### **Empty and Out of Service Cylinders**

- Mark or label them as "Empty cylinder" and store empty cylinders away from full cylinders.
- Return empties to the supplier.
- Remove regulators when not in use and store these away from grease and oil. Put protective caps on the fittings when in storage.
- Keep cylinders and fittings from becoming contaminated with oil, grease or dust.
- Do not use a cylinder that is not identified or if the label is not legible. The colors of industrial gas cylinders are not standardized.

## Safe moving of Gas Cylinders

- Remove the regulator and replace the valve protection cap before moving a cylinder.
- Move cylinders with appropriate trolleys. Use proper lifting cradles.
- Call the supplier to remove leaky cylinders immediately.

### **DO NOT**

- Do not lift a cylinder by the valve cap. Never sling with ropes or chains or lift with electromagnets.
- Do not drag, slide, or drop cylinders. They can be rolled for short distances on their base.
- Never place cylinders on their sides as rollers to move equipment.
- Do not lay acetylene cylinders on their sides. If an acetylene tank has accidentally been left on its side, set it upright for at least one hour before it is used.
- Do not try to refill a cylinder or mix gases in a cylinder.

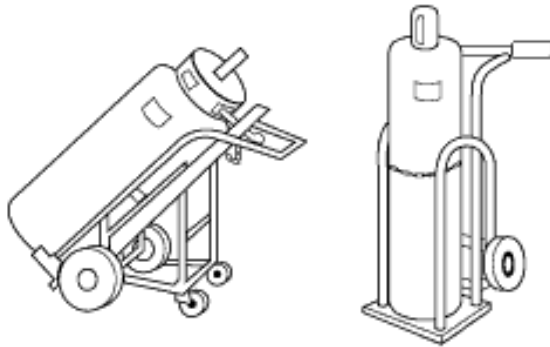

**Cylinder Trolleys**

## **RECORDS/VERIFICATION OF UNDERSTANDING**

### **Records**

- Training Records shall be maintained by the Instructor.

### **Verification of Understanding**

- A training master log will be maintained by the welding instructor.

## **SUMMARY OF CHANGES**

<b>Revision #</b>	<b>Date</b>	<b>Changes</b>	<b>Issued By</b>
1	05/29/2014	NEW	OHS Officer
2	09/30/2014	Revision	OHS Officer
3	04/23/2019	Revision, and New Format	Safety Officer
4	08/26/2024	RSS update	Safety Advisor